



VSG25A

User Manual

Signal Hound VSG25A User Manual

© 2015, Signal Hound, Inc.
35707 NE 86th Ave
La Center, WA 98629 USA
Phone 360.263.5006 • Fax 360.263.5007

Contents

| | |
|--|----------|
| 1 Introduction | 1 |
| 2 Understanding the Hardware | 1 |
| 3 Capabilities | 2 |
| 3.1 AM / FM Modulation | 2 |
| 3.2 Pulse Modulation | 2 |
| 3.3 Multi-Tone | 3 |
| 3.4 Digital Modulation | 3 |
| 3.5 ASK / FSK Modulation | 4 |
| 3.6 Custom / Arbitrary Waveform Modulation | 4 |
| 3.7 Swept Mode | 4 |
| 3.8 Talking to the Hardware | 5 |
| 4 Calibration | 5 |
| 5 Adjustments | 5 |
| 5.1 Timebase | 5 |
| 6 VSG25A Preliminary Specifications | 5 |
| 6.1.1 Frequency | 5 |
| 6.1.2 Baseband I/Q Symbol Clock | 5 |
| 6.2 Amplitude | 6 |
| 6.2.1 Modulation Relative Amplitude Accuracy | 6 |
| 6.3 VSWR | 6 |
| 6.4 Device Configuration Time | 6 |
| 6.5 Spectral Purity | 6 |
| 6.5.1 Typical SSB Phase Noise | 7 |
| 6.5.2 Harmonics | 7 |
| 6.5.3 Residual Signals | 7 |
| 6.5.4 Baseband Reconstruction Filter | 7 |
| 6.5.5 Spurious from I/Q imbalance | 8 |
| 6.6 Modulation modes | 9 |
| 6.6.1 AM | 9 |
| 6.6.2 FM | 9 |
| 6.6.3 Step Sweep | 9 |
| 6.7 Pulse | 9 |
| 6.8 Multi-tone | 10 |

| | |
|---|----|
| 6.9 PSK / QAM | 10 |
| 6.10 Custom Modulation | 10 |
| 6.11 DAC Clock Notes | 11 |
| 6.12 Inputs / Outputs | 11 |
| 6.13 Mechanical / Environmental | 11 |
| 6.14 Appendix A: Bit Mapping for Digital Modulation | 12 |

1 Introduction

The Signal Hound VSG25A Vector Signal Generator is capable of producing many of the complex signals used in today's ever-evolving wireless communications industry. Featuring a frequency range of 100 MHz to 2.5 GHz, output amplitude from -40 dBm to +10 dBm, and 100 MHz of modulation bandwidth, the VSG25A covers most telecom frequencies, as well as two major ISM bands (902-928 MHz and 2.4 to 2.5 GHz). It may be used down to 80 MHz, and -80 dBm to +13 dBm with reduced performance. It is USB-powered, weighs 5 ounces, and is small enough to carry in a pocket.



2 Understanding the Hardware

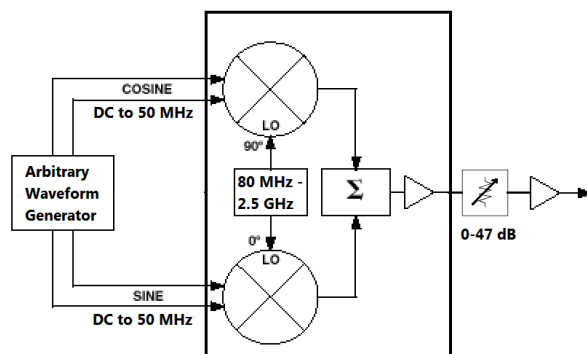

At the heart of the VSG25A is a quadrature modulator driven by an arbitrary waveform generator consisting of 2, 12-bit DAC channels, a direct digital synthesizer (DDS), and pattern memory. The waveforms represent the I and Q channels of the complex signal to be produced.

Inside the arbitrary waveform generator, there is tightly coupled pattern memory of 4k words. These words may represent an instantaneous frequency, or an I or Q value. This may not seem

like a lot, but when combined with the flexible DAC clock, this can represent 512, QAM-256 symbols with a root raised cosine filter applied, at virtually any data rate from 16 kSPS to 45 MSPS.

There is approximately 47 dB of gain control available for full 12-bit resolution. By using fewer bits, over 80 dB of gain control is possible.

The waveform period may be set longer than the pattern length as well. This is great for generating periodic shaped pulses. The pattern memory is clocked at a rate from 800 kHz to 180 MHz, divided by a prescaler (1 to 15). The pattern period shares the 800 kHz to 180 MHz clock, but has a separate prescaler, and a 16 bit counter, for periods up to $15 * 65535 = 983025$ clock cycles.

3 Capabilities

The VSG25A is capable of producing a wide variety of signals, with a good degree of precision.

3.1 AM / FM MODULATION

Amplitude modulation uses a fixed frequency, and varies the amplitude of the signal. Frequency modulation uses a fixed amplitude and varies the instantaneous frequency of the signal. Choose sine, triangle, square, ramp modulation. Modulation rates can be set from 30 Hz to 45 MHz. AM modulation depth may be set from 1% to 99%. FM peak deviation may be set up to 50 MHz. The AM and FM waveforms, being digitally generated, are quite accurate. Total harmonic distortion on an FM waveform with sine wave modulation is typically below 0.02%.

For low frequency AM / FM, where the sine / square / triangle pattern repeats at a fixed rate, the pattern memory is typically filled with 2000 amplitudes or frequencies. For example, if you select 1 kHz AM, the sample clock will be set to 2000 kHz (2 MHz), and the I and Q buffers will be filled with the selected waveform.

3.2 PULSE MODULATION

Pulse modulation is single frequency signal that is "on" for a specified width, then "off" for the remainder of the specified period. The on/off ratio is the difference in amplitude between the "on" state and the "off" state.

The typical rise time (10-90% amplitude) of 3.5 ns and fall time (90-10% amplitude) of 2.5 ns (tested at 2.45 GHz) make the VSG25A a good source for pulse modulation. These are independent of pulse width or pulse period.

If these rise / fall times are too steep, they may be shaped using a custom CSV file for an arbitrary waveform. See section on custom modulation files.

Pulse modulation is clocked at a rate from 800 kHz to 180 MHz, where the pulse width is an integer number of clocks, divided by a prescaler (1 to 15). The pulse period shares the same 800 kHz to 180 MHz

clock, but has a separate prescaler, and a 16 bit counter, for periods up to $15 * 65535 = 983025$ clock cycles. This allows very low duty cycle pulses (10.2 ns on, 10 ms off). Based on your requested pulse width and pulse period, the VSG25A software will automatically select the best clock rate and prescaler values. Pulse modulation will always have an “on” state and “off” state of at least one clock cycle.

The minimum pulse width is 6 nanoseconds, and can be adjusted in very small increments. The on/off ratio is typically >50 dB.

3.3 MULTI-TONE

The multi-tone generator can produce between 2 and 1023 equally spaced tones. These frequencies are simultaneously and continuously output. The phase relationship between tones is either random, or parabolic for minimum peak-to-average power ratio. There is even a selectable center notch built in for tests like noise power ratio, and the LO feed-through can be manually nulled for best notch performance.

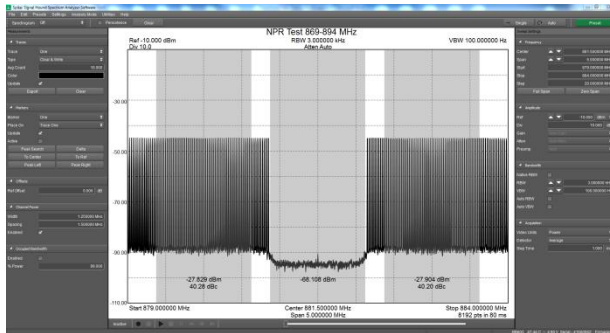

Evenly spaced tones are required because of the pattern memory limitations. The sample clock is set to an integer multiple of the tone spacing. For tone spacing below 90 kHz, this multiple is set to 2000.

For noise power ratio, many sets of 1001 tones with random phase are required to adequately simulate a multi-channel carrier. Contact Signal

Hound for additional information.

The only pre-distortion that is applied is an inverse sinc filter for flattening tone amplitudes. The VSG25A's two-tone third order intercept at the final amplifier is typically around +25 dBm, which may or may not be adequate for testing your amplifier. If additional predistortion is required for two-tone testing, a custom arbitrary waveform generator file may be used and adjusted until 3rd order products are nulled. See the section on Arbitrary / custom modulation.

3.4 DIGITAL MODULATION

Digital modulation takes user-supplied binary data and modulates the carrier signal using a pre-defined modulation type. For example, binary phase shift keying (BPSK) encodes a “0” and a “1” at two phases separated by 180 degrees (π radians). The binary sequence is continuously repeated without gaps.

BPSK, DBPSK, QPSK, DQPSK, OQPSK, $\pi/4$ DQPSK, 8PSK, 16PSK, 16QAM, 64QAM, and 256QAM are supported. Symbol rates from 4 kHz (max 128 symbols) or 16 kHz (max 512 symbols), up to 45 MHz are supported. Raised cosine and root-raised cosine filtering are available, with selectable filter roll-off.

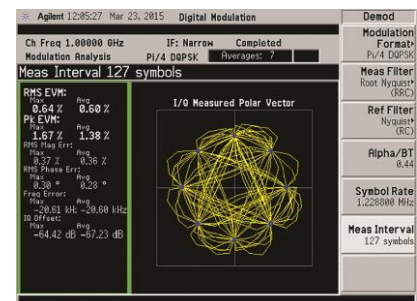

Typical EVM for a $\pi/4$ DQPSK signal is below 1% RMS. A digital pattern editor, with the ability to add PN7 and PN9 sequences with one click, and save-load support, is included. When the number of bits is not evenly divisible by the number of bits per symbol, the data will be padded with zeros. For differentially encoded signals, the last symbol may be modified or an additional symbol may be appended for smooth pattern repetition.

The software automatically converts the symbols to a repeating pattern of 1024 to 2048 samples, where each symbol is encoded into 4, 8, or 16 samples (depending on number of symbols and symbol rate). More samples per symbol means lower out-of-band spurious.

3.5 ASK / FSK MODULATION

Amplitude- and frequency- shift keyed (ASK and FSK) modulation types are available, and use the same digital pattern editor as PSK / QAM. A Gaussian filter, with adjustable roll-off, may be turned on or off. For MSK modulation, simply set your modulation index to 0.5. For GMSK modulation, enable the Gaussian filter and set the filter coefficient (typically 0.3 to emulate GSM, 0.5 to emulate Bluetooth, etc.).

3.6 CUSTOM / ARBITRARY WAVEFORM MODULATION

Modulation using a custom / arbitrary waveform is also available. While the Signal Hound software does not have advanced signal generation software, I/Q waveforms can be built using other software packages, and then pasted into a CSV or text file. This input file, which can be modified in any spreadsheet software, controls center frequency, amplitude, baseband clock rate, number of samples, and signal period, followed by the actual samples. Several examples are provided, including a simple 1 MSPS, 8-bit unfiltered BPSK packet, a windowed sinc pulse, and a chirp radar signal. There are also some spreadsheet examples of how to generate these waveforms.

3.7 SWEPT MODE

Ramp Sweep frequency modulates the local oscillator, giving you a sweep of up to a 100 MHz span. However, due to pattern memory limitations, this sweep would be limited to 100 μ s. Maximum ramp sweep time is inversely related to sweep span, so it must be ≤ 10 ms for a 1 MHz span, and ≤ 1 ms for a 10 MHz span, etc.

Step sweep is just that. It operates as a CW generator at your first frequency. After an interval of **at least dwell time**, it steps to the next frequency, until all frequencies are complete, then it repeats. Even with a 1 ms dwell time, you may only get 8-10 steps per second.

3.8 TALKING TO THE HARDWARE

Most users will choose to use our included software to communicate with the VSG25A. If you need to develop your own software, an Application Programming Interface, or API, exposes all of the functions of the hardware and software. See the API manual for more information.

4 Calibration

Contact Signal Hound for calibration services or software.

5 Adjustments

5.1 TIMEBASE

The 24 MHz internal timebase is easily adjusted to within 1 ppm using a 1.8 mm or 1/16" slotted screwdriver, found in many common jewelers screwdriver kits. To accomplish this, generate a CW signal of known frequency (e.g. 1 GHz), and adjust using a spectrum analyzer, measuring receiver, or counter.

Contact Signal Hound for any additional adjustments.

6 VSG25A Preliminary Specifications

6.1.1 Frequency

Range: 100 MHz to 2.5 GHz (useable down to 80 MHz with unspecified performance)

Resolution: < 1 Hz

Timebase Accuracy (excluding temperature drift): ± 5 ppm / year

Timebase drift over temperature: typically -0.2 ppm / °C.

Timebase adjustable to ± 1 ppm after 15 minute warmup, using 1.8mm slotted screwdriver

6.1.2 Baseband I/Q Symbol Clock

Range: 53.333 kHz to 180 MHz

Accuracy: Timebase Accuracy + Clock PLL Error

Clock PLL error: zero for 3 ½ significant digits, and for standard communications rates

Worst case Clock PLL error: 0.07%. Software reports errors greater than 0.001%

See **Clock Notes** for some examples.

6.2 AMPLITUDE

CW Absolute Amplitude Accuracy: -40 to +10 dBm, +/- 1.5 dB (as measured by an RF power meter)

Resolution 0.01 dB

6.2.1 Modulation Relative Amplitude Accuracy

Bandwidth (BW) \leq 10 MHz, BW $<$ 3% of Center frequency (CF): ± 0.25 dB

For multi-tone and PSK/QAM, inverse sinc correction is applied automatically. Typical roll-off after correction is roughly parabolic, down 0.2 dB at 25 MHz offset from center and 0.8 dB at 50 MHz offset from center.

All other modulation conditions: ± 1 dB typical

Carrier feed-thru (0 dBm output power) $<$ -45 dBc, $<$ -60 dBc typical

6.3 VSWR

100 MHz to 2.2 GHz, $<$ 2.0:1 typical

80 MHz to 2.5 GHz, $<$ 3.0:1 typical

6.4 DEVICE CONFIGURATION TIME

500 ms typical

6.5 SPECTRAL PURITY

6.5.1 Typical SSB Phase Noise

| Typical Phase Noise (1 GHz) | |
|-----------------------------|--------|
| Offset | dBc/Hz |
| 100 Hz | -68 |
| 1 kHz | -88 |
| 10 kHz | -102 |
| 100 kHz | -105 |
| 1 MHz | -132 |

6.5.2 Harmonics

Harmonic output filter: Single 2.7 GHz (nominal) low pass filter

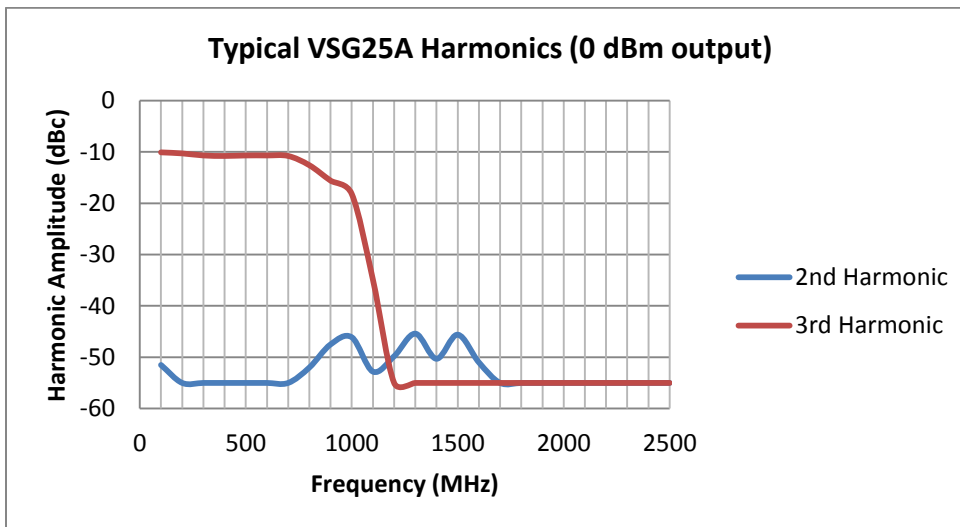

6.5.3 Residual Signals

10 MHz to 2.5 GHz: < -80 dBm typical

6.5.4 Baseband Reconstruction Filter

None

Typical Spurious from DAC Aliasing:

| Oversampling Factor ⁽¹⁾ | Out-of-band Spurious (dBc) | Example |
|------------------------------------|----------------------------|--|
| 1000 | -60.0 | Analog AM / FM, sine wave modulation, 10 kHz deviation |
| 400 | -52.0 | Multi-tone, 11 tones |
| 100 | -39.9 | Multi-tone, 41 tones |
| 40 | -31.8 | Multi-tone, 101 tones |
| 16 | -23.6 | Digital PN7, or 251 tones |
| 8 | -17.1 | Multi-tone, 501 tones |
| 4 | -10.5 | Digital PN9, or 1001 tones |

Note 1: Oversampling factor defined as (DAC clock rate) / (Bandwidth)

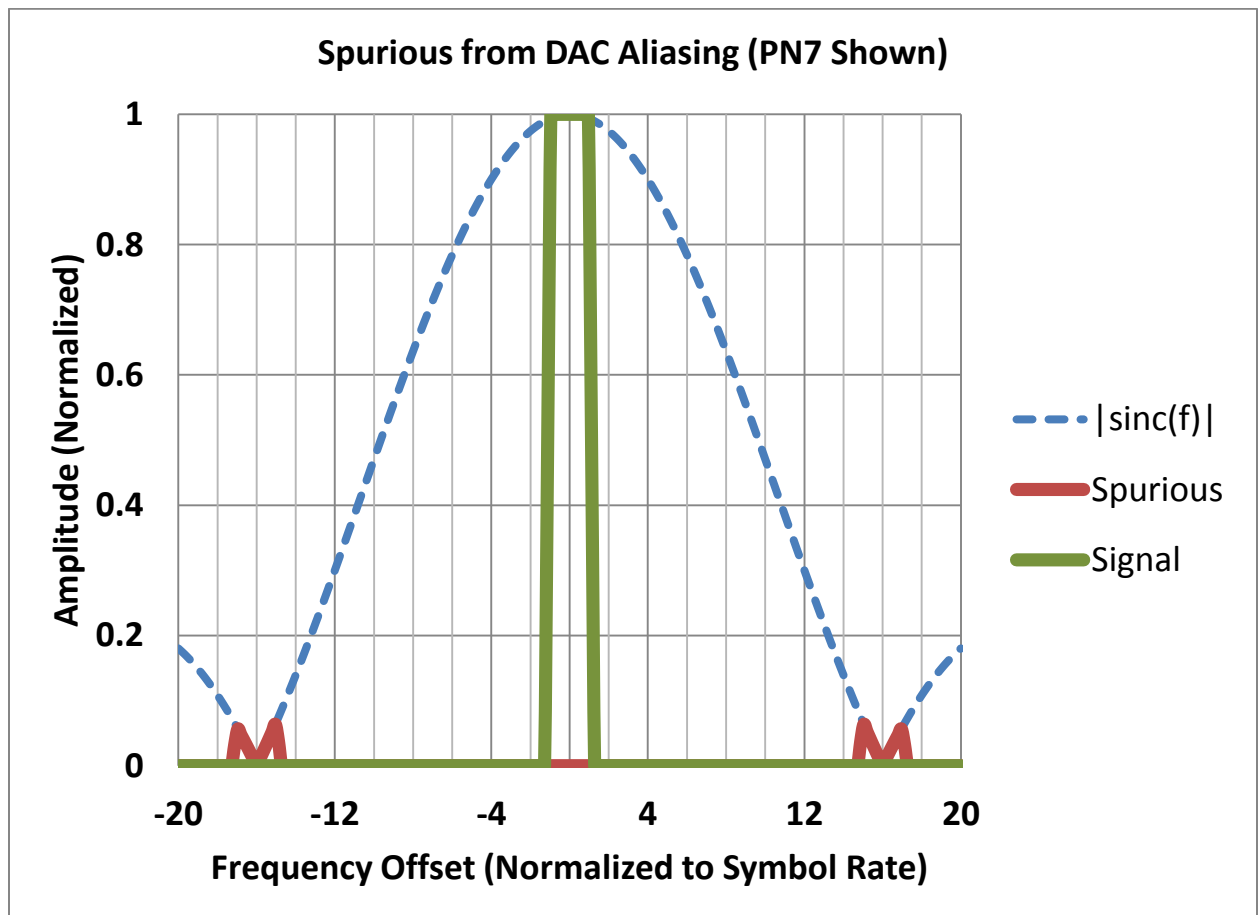

6.5.5 Spurious from I/Q imbalance

<-40 dBc typical

6.6 MODULATION MODES

6.6.1 AM

Modulation Rate: 30 Hz to 40 MHz. Same accuracy as symbol clock accuracy.

Modulation depth: 1% to 99%, $\pm 1\%$

Modulation shapes: sine, triangle, square, and ramp.

THD: $< 1\%$ (1 kHz sine modulation)

6.6.2 FM

FM Modulation Rate: 30 Hz to 40 MHz. Same accuracy as symbol clock accuracy.

Modulation deviation: $\pm 1\%$ (typically $\pm 0.1\%$)

| Maximum Modulation Index (Deviation / Rate) | |
|--|----------------------|
| Modulation Rate | Max Modulation Index |
| ≤ 3 kHz | 15000 |
| >3 kHz, ≤ 12 kHz | 4000 |
| >12 kHz, ≤ 45 kHz | 1000 |
| >45 kHz, ≤ 75 kHz | 600 |
| > 75 kHz | 300 (or 50 MHz) |

Please note that above 10% of maximum modulation index, spurious signals may be observed in nearby channels.

Modulation shapes: sine, triangle, square, and ramp.

THD: $< 0.1\%$ (100 kHz offset, 1 kHz rate sine modulation), 0.01% typical

6.6.3 Step Sweep

Frequency accuracy: Same as CW

Number of points: 2 to 10,000

6.7 PULSE

Pulse width: 6 ns to 25 ms

Typical rise time (10-90%): 3.5 ns (2.4 GHz output)

Typical fall time (90-10%): 2.5 ns (2.4 GHz output)

Pulse width resolution: typically better than 0.1%

Pulse Period: Must be rational function⁽¹⁾ of pulse width. 12 ns to 1 s.

Duty cycle: Minimum 0.00025% (pulse period ≤1.0 s), maximum 99.9% ("off" time > 6 ns).

Software reports actual pulse width and pulse period, which may vary slightly from requested values.

On / off ratio > 45 dB (typically 60 dB)

*Note 1: Internally, pulse width must be 1 to 2047 * M clocks, where M is 1 to 15, and Pulse Period must be 2 to 65,535 * N clocks, where N is 1 to 15. Clock can be 800 kHz to 180 MHz.*

6.8 MULTI-TONE

Tone count, 2 to 1023

Tone spacing: 1 kHz to 10 MHz, accuracy same as symbol clock accuracy.

Tone Phase Relationship: parabolic or random, where parabolic tone phases are $\pi (k-1)^2 / N$, where N is the number of tones for the k'th tone from center.

Maximum span: 100 MHz

6.9 PSK / QAM

Modulation Type: BPSK, QPSK, DQPSK, PI/4 DQPSK, OQPSK, 8-PSK, 16-PSK, 16 QAM, 64 QAM, 256 QAM. Other modulation modes may be available.

Filter: Raised cosine or RRC (root Nyquist), alpha 0.01 to 1.0

Pattern: PN7, PN9, custom

| Samples per Symbol | Maximum symbol count | Minimum Symbol Rate | Maximum Symbol Rate |
|--------------------|----------------------|---------------------|---------------------|
| 4 | 512 (PN9) | 16 kHz | 45 MHz |
| 8 | 256 | 8 kHz | 22.5 MHz |
| 16 | 128 (PN7) | 4 kHz | 11.25 MHz |

EVM (RMS), QPSK, 1 MSPS, < 1% typical

6.10 CUSTOM MODULATION

User-defined continuous modulation patterns use a waveform memory of 2 to 2048 I/Q samples, and a period from 2 to 65535 samples, using a clock rate of 53.333 kHz to 180 MHz.

When the active segment is shorter than the period, the first and last samples must match. This value (typically 0, 0) will be held during the "off" time.

Amplitude accuracy: Same as digital modulation when $\text{RMS}(I^2 + Q^2) = 1.0$

Input range: -1.5 to 1.5

6.11 DAC CLOCK NOTES

DAC clock values to match your selected pattern are automatically selected for you, using the formula below. Where an exact match is not available, the software will select the set of values closest to the desired clock rate.

DAC CLOCK = $24 \text{ MHz} * N / (M * D * P)$, where N is 1 to 4095, D is 1 to 127, M is 1 to 511, P is 1 to 15, and $100 \leq (24N/M) \leq 200$.

Example 1: 13.4912 MHz (1.6864MHz x 8): $(24 * 2108) / (375 * 10)$, 0 ppm error

Example 2: 2.1666667 MHz (270.833333 kHz x 8), GSM: $(24 * 611) / (144 * 47)$, 0 ppm error

Example 3: 9.8304 MHz (1.2288 MHz x 8), CDMA: $(24 * 768) / (125 * 15)$, 0 ppm error

Example 4: 1.0001 MHz: $(24 * 1250) / (297 * 101)$, 0.01 ppm error

6.12 INPUTS / OUTPUTS

Data and Power: USB 2.0 type B

RF output: SMA (F)

6.13 MECHANICAL / ENVIRONMENTAL

Power Requirements: USB-powered, 4.75 – 5.25V, 450 mA typical. *4.75V-5.25V is required to meet published specifications. Typical behavior for USB voltages below 4.75V, such as tablet PCs, is increased rolloff and reduced amplitude for signals wider than 5 MHz bandwidth.*

Operating temperature (calibrated): 18 to 28 °C Operating temperature (uncalibrated): 0 °C to 50 °C

Size: 5.5" x 2.25" x 1"

Weight: 5 oz.

6.14 APPENDIX A: BIT MAPPING FOR DIGITAL MODULATION

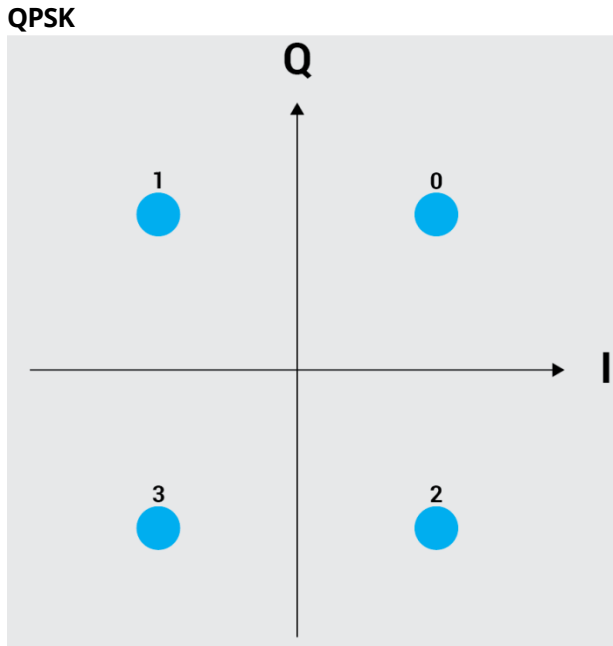

DQPSK

| Data | Phase Change |
|------|--------------|
| 0 | 0 |
| 1 | $+\pi/2$ |
| 2 | $-\pi/2$ |
| 3 | π |

$\pi/4$ DQPSK

| Data | Phase Change |
|------|--------------|
| 0 | $+\pi/4$ |
| 1 | $+3\pi/4$ |
| 2 | $-\pi/4$ |
| 3 | $-3\pi/4$ |

D8PSK

| Data | Phase Change |
|------|--------------|
| 0 | 0 |
| 1 | $+\pi/4$ |
| 2 | $+3\pi/4$ |
| 3 | $+\pi/2$ |
| 4 | $-\pi/4$ |
| 5 | $-\pi/2$ |
| 6 | π |
| 7 | $-3\pi/4$ |

8-PSK

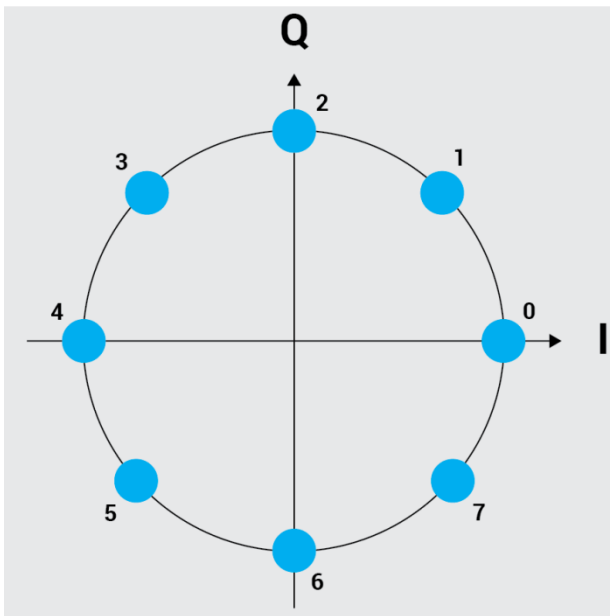

16-QAM

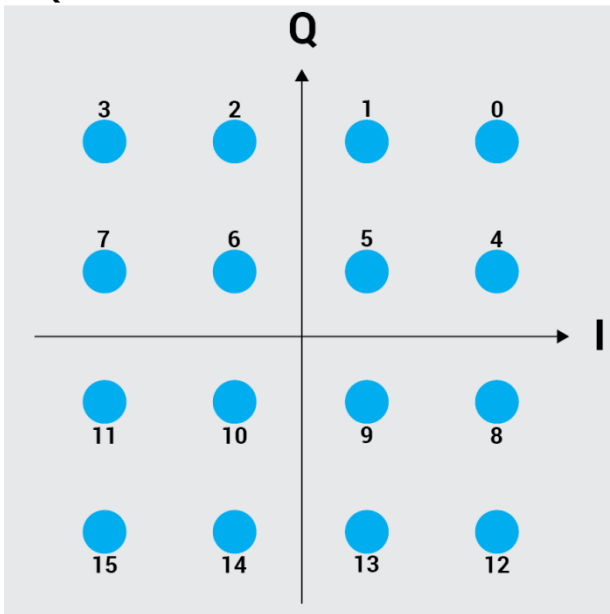

Note: Positive I-axis is to the right, positive Q-axis is to the top.

16-PSK is similar to 8-PSK, except for a phase step of $\pi/8$.

Offset QPSK is the same as QPSK, except the Q is delayed by $\frac{1}{2}$ symbol.

64-QAM and 256-QAM are encoded similarly to 16-QAM (right-to-left, top-to-bottom).

FSK / MSK data is type 2 (not differentially encoded).

ASK data: "0" is low amplitude, "1" is high amplitude.